

HOTEL ITEMS

TWO TIER TOWEL RACK

8281521



PRODUCT NAME: TWO TIER TOWEL RACK

PRODUCT CODE: 8281521

MATERIAL: All-brass construction

KEY FEATURES: Contemporary design.
Simple and straight forward lines.
Strong linear silhouette.

STOCKED FINISHES:

- Polished Chrome (99)
- Brushed Nickel (81)
- Polished Nickel (68)

SPECIAL FINISHES AVAILABLE: Please see our website for full list samples

WARRANTY:
Lifetime Limited (Residential Use)
One Year (Commercial Use)

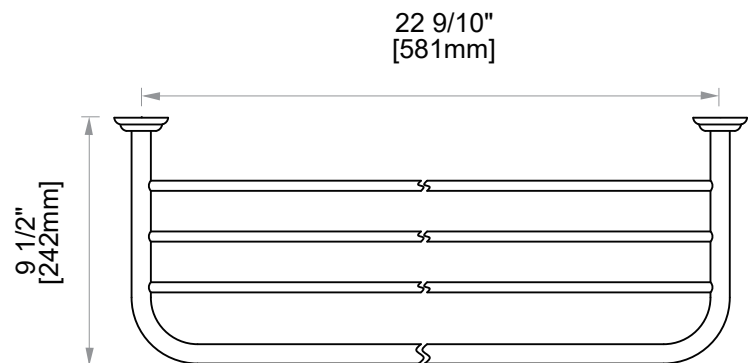
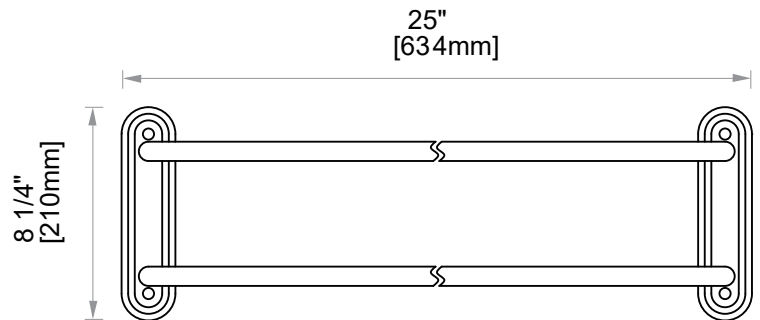

NOTE: Dimensions and specifications are subject to change without notice.