

9500 SERIES (1.25"/32mm)

GRAB BAR

AVAILABLE IN: 12"/18"/24"/36"/42"
8289512/9518/9524/9536/9542

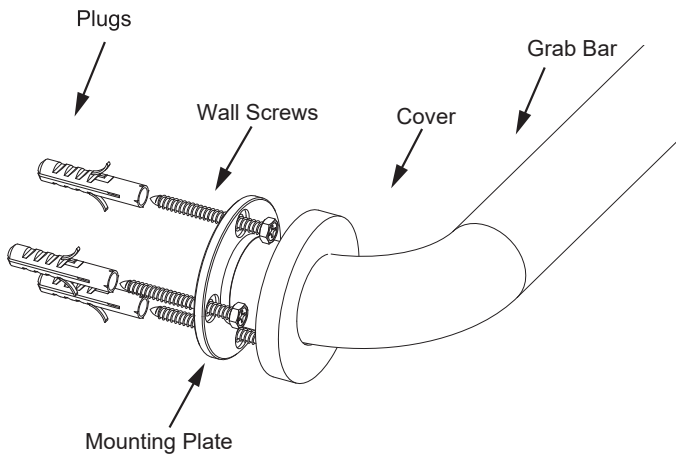

Tools required for installation

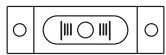

Level



Pencil



Wrench

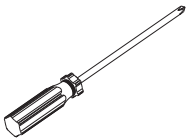

Screwdriver

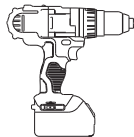

Drill



Hammer

A=Plate TOP holes center to center distance

B=Plate TOP hole to BOTTOM hole distance

C=Plate TOP/BOTTOM holes to MID hole distance

Product Code	Sizes (Inches/mm)		
	A	B	C
8289512	11 3/4" /300	1 3/4"/45	1"/22.5
8289518	17 3/4"/450	1 3/4"/45	1"/22.5
8289524	23 5/8"/600	1 3/4"/45	1"/22.5
8289536	35 1/2"/900	1 3/4"/45	1"/22.5
8289542	42 1/8"/1070	1 3/4"/45	1"/22.5

Fig.1

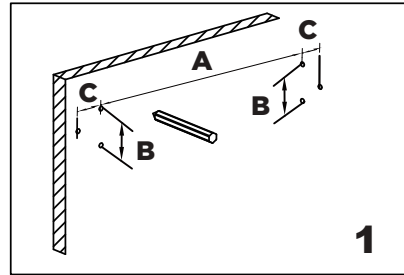

Mark (on the wall) locations of plugs through mounting plate using a pencil, refer to Fig.1

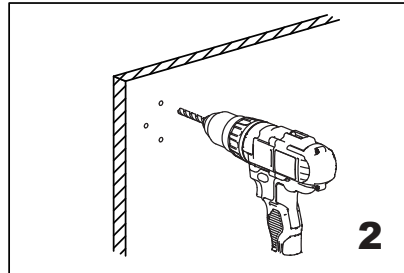

Drill 3/16" holes, make sure to keep drill level

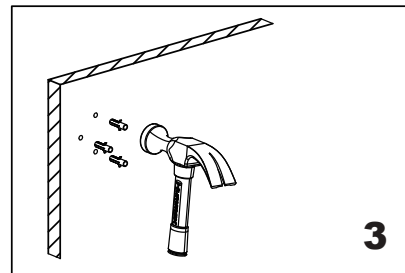

Insert plugs into drilled holes, using a hammer to tap the plugs in, be careful not to break tile

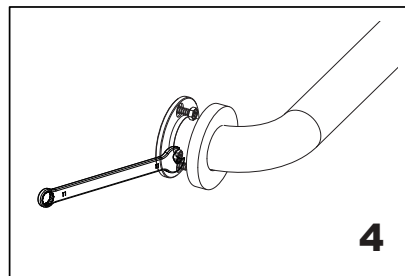

Driver bolt nut directly into holes

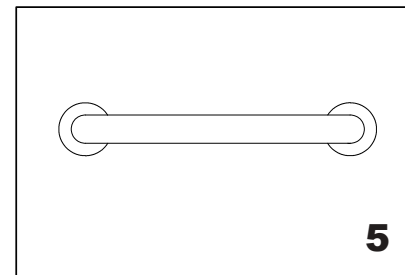

Tighten the cover on the Mounting plate